

KOALA 1300TW AF

110x110



Refrigerated container for the transport of food/pharmaceutical products at a controlled temperature

- Available in versions:
 - AF: temperature adjustment range: from **0°C to +10°C**;
 - AFH: with heating kit and temperature adjustment range: from **0°C to +40°C**.
- **EXTERNAL DIMENSIONS ASIAN PALLET 110x110:** maximum convenience in loading and unloading of goods on vehicle.
- Insulation offered by container walls ensures that the temperature maintenance is guaranteed with a minimum number of ignitions of the cooling unit; this contributes limiting energy consumption.
- Cooling unit is triggered when inner temperature is higher than the temperature set with the programmable digital thermostat. This allows to maintain a constant temperature even in case of very high external temperatures.
- In the AFH versions, the heating unit is triggered when inner temperature is lower than the temperature set with the programmable digital thermostat. This allows to maintain a constant temperature even in case of very low external temperatures.
- Total compliance with the cold chain at all stages of transport.
- It can be transported using conventional vehicles: it allows to simultaneously transport chilled and ambient temperature products using a single non-insulated vehicle.
- Equipped with a low consumption fridge unit.
- It can be powered at 230Vac, using normal mains power or it can be connected to the battery (or auxiliary battery) of the vehicle by inverter.
- Manufactured using the rotational moulding technology: mono-block container and door (free of sharp edges, joints and welds).
- **Fully recyclable** at the end of the operating life.







MANUFACTURING MATERIALS

Polyethylene	inner and outer walls of the container and lid; suitable for food contact	Polyurethane	insulating material between the walls of the container and of the lid; free of CFC and HCFC
Silicone	gasket	Rubber and polyamide	castors (rubber tread and polyamide core)
Galvanized steel	cooling unit frame, hinge rods, plates connecting rods hinge, castors support	Stainless steel	handling handles, locking handle, inner rod of the door
Polypropylene	hinges		

TECHNICAL CHARACTERISTICS

<p>AF Version</p>	<ul style="list-style-type: none"> • from 0°C to +10°C 	<p>AFH Version</p>	<ul style="list-style-type: none"> • from 0°C to +40°C
<p>+/- 0,5 °C</p>	<p>Degree of accuracy in temperature adjustment:</p> <ul style="list-style-type: none"> • +/-0,5 °C 		<p>Protection against voltage drops of the vehicle battery, in case of falling below of the limit value of 11V</p>
	<p>Equipped with three cables: for power supply to 230Vac 50-60Hz</p>		<p>For power supply to 12Vdc</p> <ul style="list-style-type: none"> • with Anderson connectors • with Anderson terminal for connection to the Koala and fork terminals for connection to the battery of the vehicle
	<p>Hermetic compressor with electronic control unit for adjustment and control equipped with overvoltage protections</p>	<p>GAS</p>	<p>Coolant gas:</p> <ul style="list-style-type: none"> • R452A
	<p>Cooling unit performance guaranteed for use at ambient temperature:</p> <ul style="list-style-type: none"> • from +10°C to +30°C 		<p>Container (insulated case) guaranteed for use:</p> <ul style="list-style-type: none"> • from -30° to +100°C
	<p>USB data logger available (on request) to record temperature data during transport</p>		<p>Adjustment and control of the temperature with programmable digital thermostat</p>
	<p>Equipped with 4 rubber coated castors of 125 mm (2 fixed and 2 swivel of which one equipped with brake) Support runners plate integrated in the container.</p>		<p>Possibility to insert:</p> <ul style="list-style-type: none"> - Pallets with galvanized steel frame 6 feet h 120 mm - 4 feet h 120mm in galvanized steel
	<p>The ventilation system ensures a greater speed and uniformity of diffusion of the cold inside the container</p>		<p>Easily removable door seal</p>

TECHNICAL CHARACTERISTICS

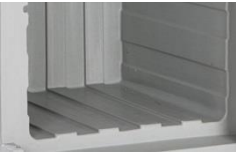
	<p>Stainless steel locking handle with release button, it is prepared for the use of tamper-proof system</p>		<p>Insulated with CFC and HCFC-free polyurethane foam</p>
	<p>Label holder (on request) for the identification of the content or destination. Suitable for A5 format documents</p>		<p>Double-pivot hinge system. Better door stability over time</p>
	<p>Door opens up to 270° with door retaining catch</p>		<p>Stainless steel rod with 2 hooks integrated inside the door</p>
	<p>Mono-block structure, no sharp edges, joints and welds</p>		<p>Internal grooves improving good air circulation</p>

TECHNICAL SPECIFICATIONS

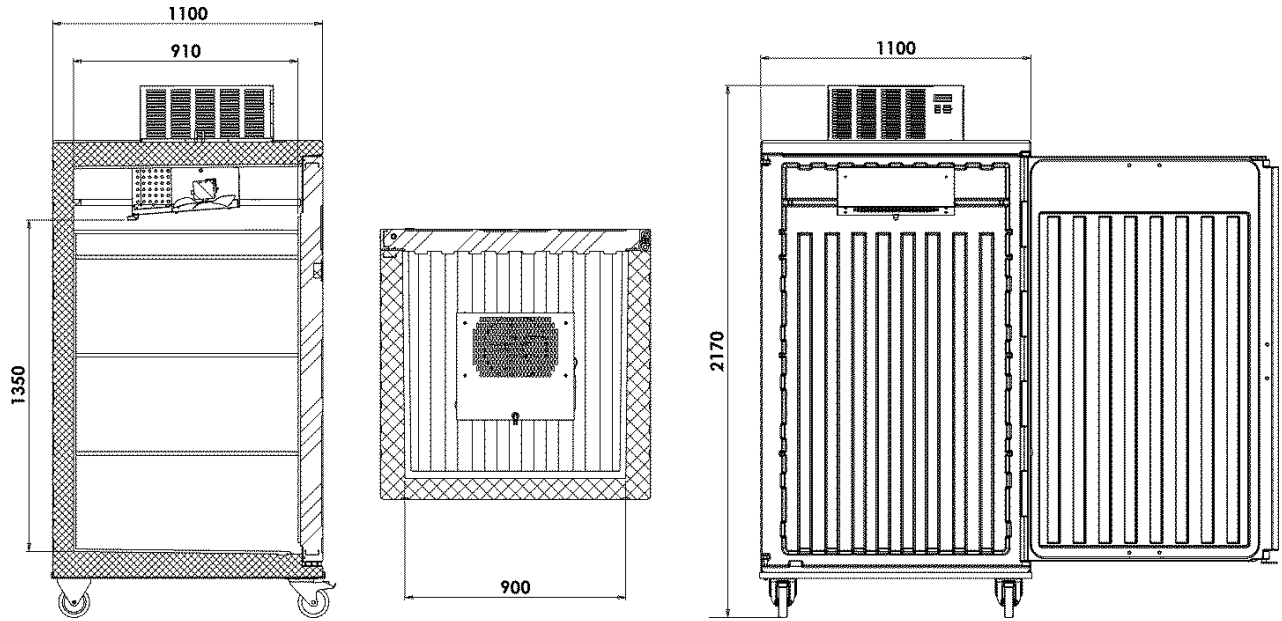

Model	Code	Nominal absorption	Fuses			
AF VERSION						
Koala 1300TW AF cooling unit on top ventilated from 0°C to +10°C	K130TAFTVDYM1	1A a 230Vac 20A a 12Vdc	4A per 230Vac 30A per 12Vdc			
AFH VERSION (with heating kit)						
Koala 1300TW AFH cooling unit on top ventilated from 0°C to +40°C	K130TAFTVDZM1	1A a 230Vac 20A a 12Vdc	4A per 230Vac 30A per 12Vdc			
Model	Code	Colour	Externe (mm)	Dim. interne (mm)	Capacity l	Weight Kg
Koala 1300TW AF/AFH cooling unit on top ventilated		melange grey blue	1100X1100Xh2170	900x910xh1350	1115	175
ACCESSORIES						
Grid in stainless steel	AEA024	stainless steel	935x890xh16			7
Label holder in polycarbonate	AMC101	trasparente	173xh200	148xh210 -A5-		